



SERIES K-MS MOR

TECHNICAL CHARACTERISTICS

- Aluminium alloy construction
- High efficiency impeller

OPTIONS

- Special Voltages (IEC 60038)
- Surface treatments
- Increased seal version

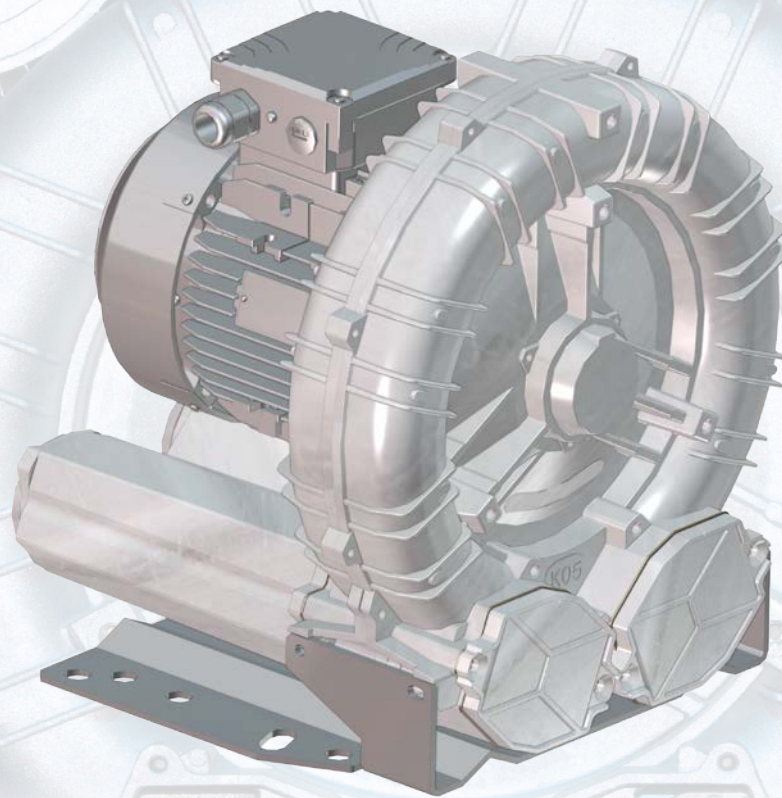

Data sheet

LATERAL CHANNEL BLOWER-EXHAUSTER

SERIES MS – RANGE MOR

PRESSURE

Model	N 2900 rpm [kW]	N 3500 rpm [kW]	Q max 2900 rpm [m³/h]	Q max 3500 rpm [m³/h]	ΔP max 2900 rpm [hPa] (mbar)	ΔP max 3500 rpm [hPa] (mbar)	Leq¹ 2900 rpm [Lp] [dB(A)]	Leq¹ 3500 rpm [Lp] [dB(A)]	Weight² max [kg]
K03-MS	0,37	0,43	74	89	130	120	59,7	61,7	11
	0,55	0,63	74	89	180	200	60	62	12
K04-MS	0,75	0,9	137	166	140	120	62,6	64,6	15,8
	1,1	1,3	137	166	200	175	62,8	64,8	16,5
K05-MS	1,5	1,75	137	166	250	250	63	65	19,5
	1,1	1,3	219	265	130	100	68,2	70,2	22,5
	1,5	1,75	219	265	175	160	68,5	70,5	23,5
K06-MS	2,2	2,55	219	265	270	260	68,8	70,8	26,5
	3	3,45	219	265	300	350	69,1	71,1	30,5
	2,2	2,55	304	366	180	150	71	73	31,2
K07-MS	3	3,45	304	366	250	220	71,3	73,3	32,5
	4	4,6	304	366	340	325	71,6	73,6	41
	2,2	2,55	414	499	130	100	76,4	78,4	46,5
K08-MS	3	3,45	414	499	200	175	76,7	78,7	47,5
	4	4,6	414	499	280	250	77	79	51
	5,5	6,3	414	499	400	375	77,3	79,3	61,5
K09-MS	3	3,45	536	647	125	100	77,4	79,4	49
	4	4,6	536	647	180	150	77,7	79,7	52,5
	5,5	6,3	536	647	275	250	78	80	63
	7,5	8,7	536	647	400	375	78,3	80,3	68
K10-MS	9,2	10,6	536	647	450	450	78,6	80,6	77,5
	4	4,6	663	800	130	85	78	80	62
	5,5	6,3	663	800	210	150	78,2	80,2	72,5
	7,5	8,7	663	800	290	250	78,5	80,5	77,5
	9,2	10,6	663	800	350	325	78,7	80,7	87
K11-MS	11	12,7	663	800	450	400	79	81	87,5
	5,5	6,3	782	944	160	115	78,1	80,1	75
	7,5	8,7	782	944	250	200	78,5	80,5	80
	9,2	10,6	782	944	300	270	79	81	89,5
	11	12,7	782	944	400	375	79,4	81,4	90
K12-MS	15	17,4	782	944	500	500	79,6	81,6	95
	7,5	8,7	915	1105	175	130	80	82	83,5
	9,2	10,6	915	1105	230	175	80,1	82,1	93
	11	12,7	915	1105	300	250	80,4	82,4	93,5
	15	17,4	915	1105	400	350	80,7	82,7	98,5
K75-MS	18,5	21,5	915	1105	500	500	83,6	85,6	128,5
	9,2	10,6	1022	1234	150	100	80,6	82,6	96,5
	11	12,7	1022	1234	200	150	80,9	82,9	97
	15	17,4	1022	1234	300	275	81,2	83,2	102
K75-MS	18,5	21,5	1022	1234	425	375	84,1	86,1	132
	4	4,6	477	576	150	100	77,4	79,4	51,5
	5,5	6,3	477	576	250	200	77,7	79,7	62
	7,5	8,7	477	576	325	300	78	80	67

INSTALLATION

- For proper use, the blower should be equipped with inlet FILTER and Flow Relief VALVE; other accessories available on request.
- Ambient temperature from -15° to +40°C (+5° to +104° F).
- Specifications subject to change without notice.
- Before installation read carefully all instructions.

¹ Noise measured at 1 m distance with inlet and outlet ports piped, in accordance to ISO 3744

² Value refers to the weight of the machine with 3 Phase motor if MOR range, without motor if GOR or GVR range.

N: Installed motor power

Q: Flow rate

P: Differential pressure

Leq: Noise

SERIES MS – RANGE MOR

PRESSURE

2900 rpm (50 Hz)

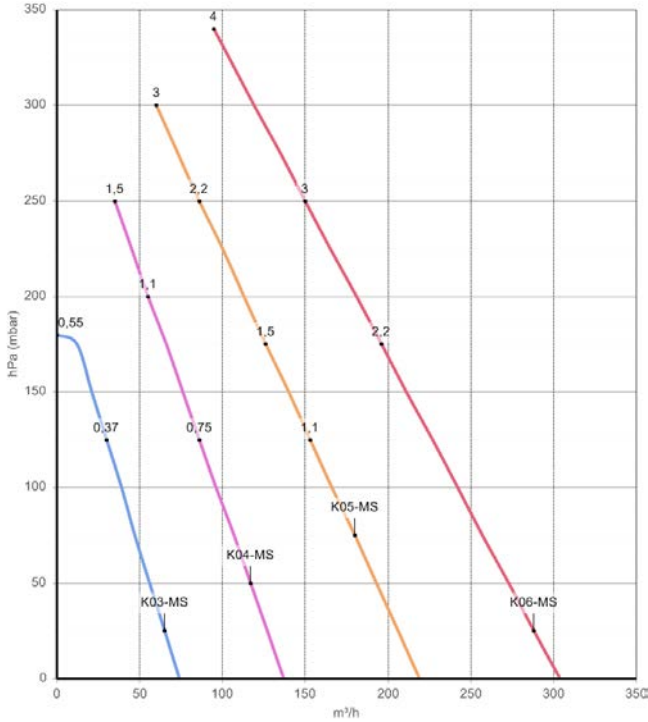

3500 rpm (60 Hz)

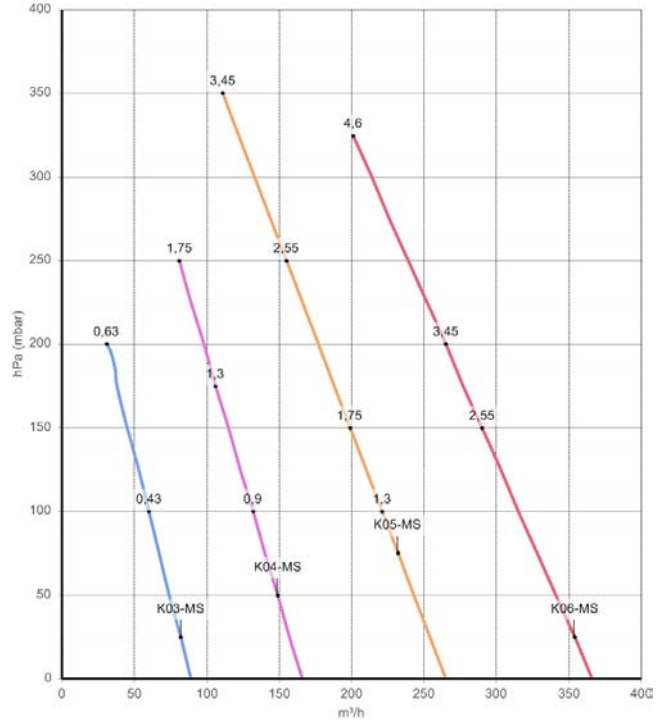

FLOW RATE

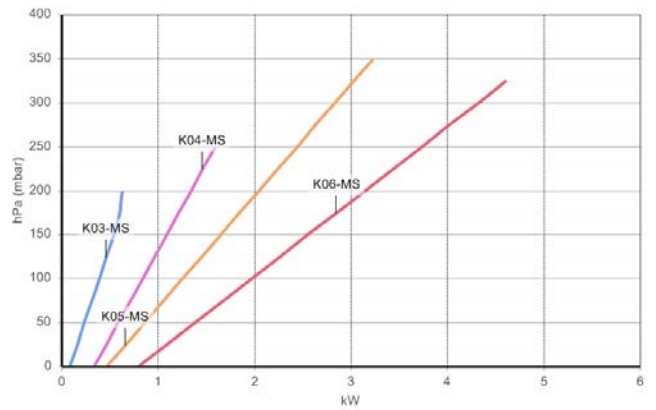
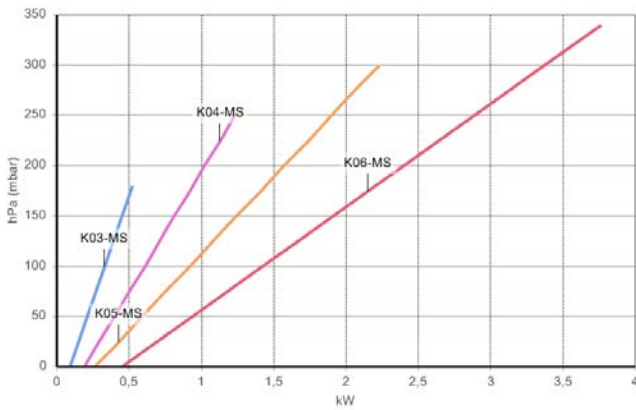

ABSORBED POWER

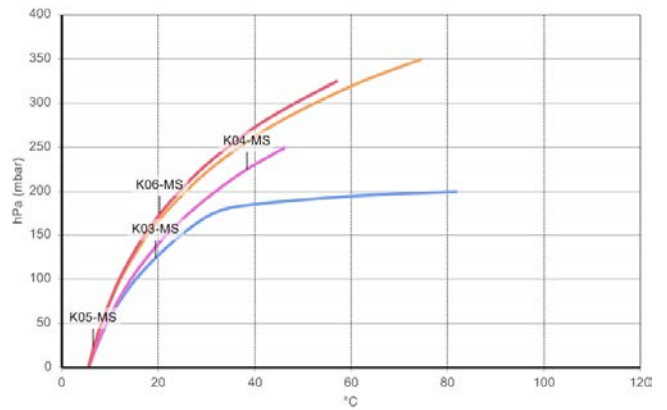
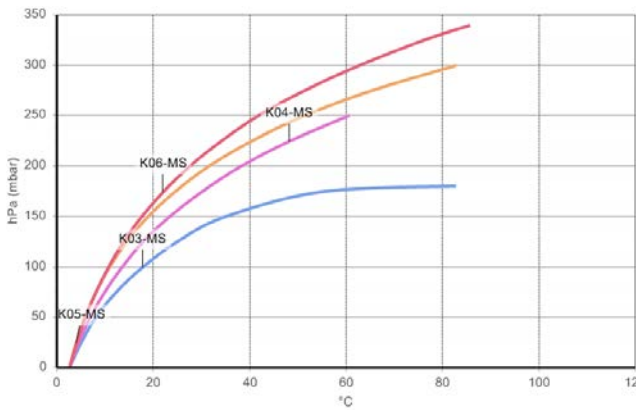

TEMPERATURE INCREASE

Curves refer to air at 20°C (68° F) temperature and 1013 mbar (29.92 In Hg) atmospheric pressure (abs) measured at inlet port.
 Values for flow, power consumption and temperature rise: ±10% tolerance
 Data can change without prior notice

SERIES MS – RANGE MOR

PRESSURE

2900 rpm (50 Hz)

3500 rpm (60 Hz)

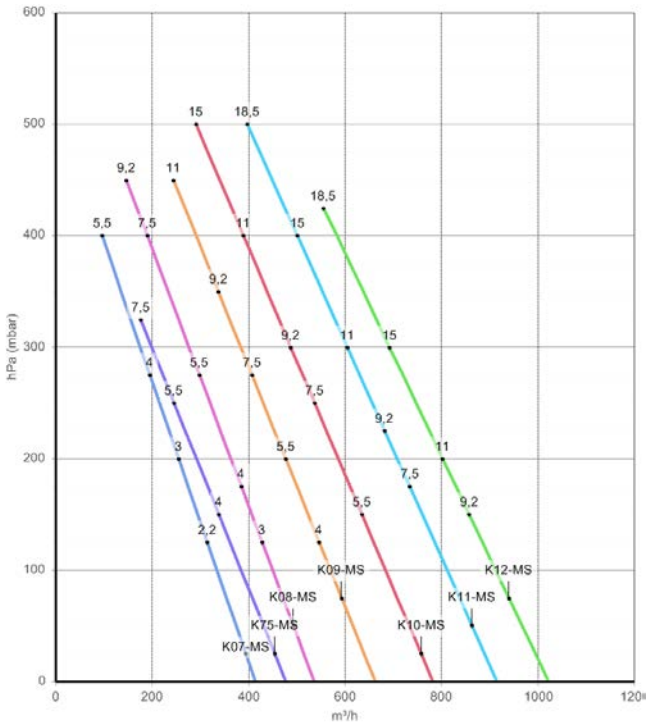

FLOW RATE

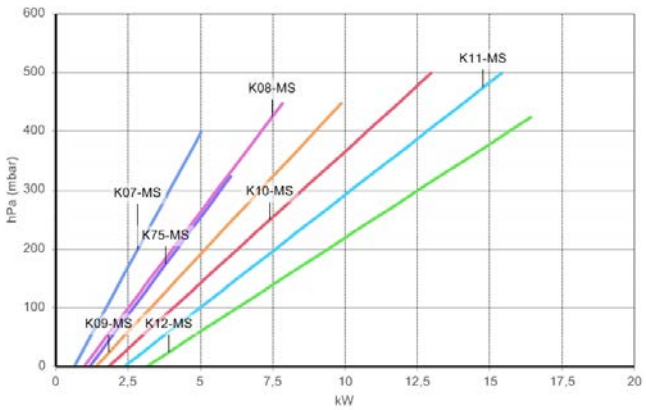
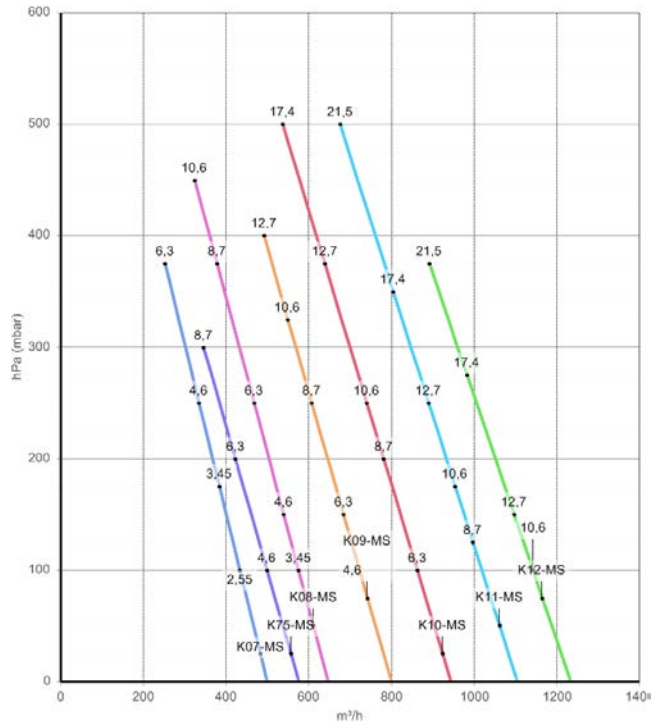

ABSORBED POWER

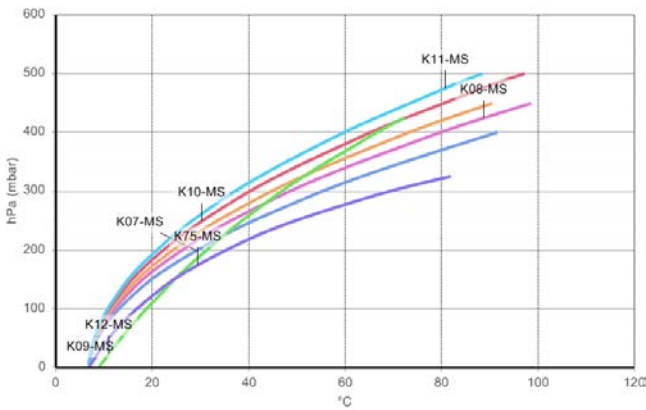
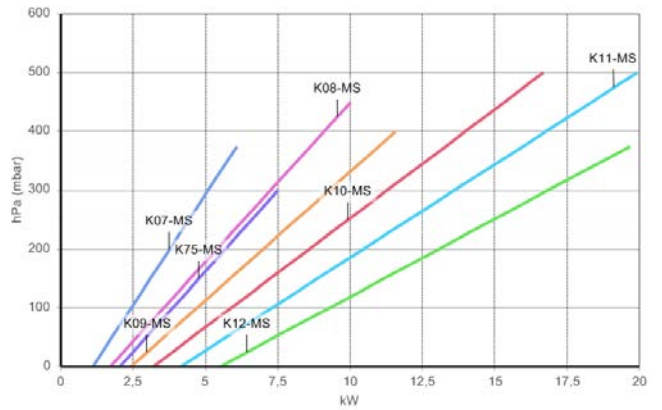

TEMPERATURE INCREASE

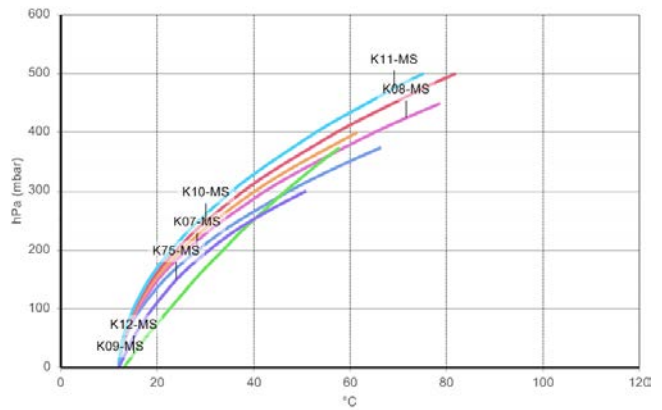

Curves refer to air at 20°C (68° F) temperature and 1013 mbar (29.92 In Hg) atmospheric pressure (abs) measured at inlet port.
 Values for flow, power consumption and temperature rise: ±10% tolerance
 Data can change without prior notice.

SERIES MS – RANGE MOR

VACUUM

Model	N 2900 rpm [kW]	N 3500 rpm [kW]	Q max 2900 rpm [m ³ /h]	Q max 3500 rpm [m ³ /h]	ΔP max 2900 rpm [hPa] (mbar)	ΔP max 3500 rpm [hPa] (mbar)	Leq ¹ 2900 rpm [Lp] [dB(A)]	Leq ¹ 3500 rpm [Lp] [dB(A)]	Weight ² max [kg]
K03-MS	0,37	0,43	74	89	120	120	58,7	60,7	11
	0,55	0,63	74	89	160	200	59	61	12
K04-MS	0,75	0,9	137	166	140	120	61,6	63,6	15,8
	1,1	1,3	137	166	200	175	61,8	63,8	16,5
K05-MS	1,5	1,75	137	166	225	250	62	64	19,5
	1,1	1,3	219	265	175	160	67,2	69,2	22,5
	1,5	1,75	219	265	175	160	67,5	69,5	23,5
K06-MS	2,2	2,55	219	265	240	260	67,8	69,8	26,5
	3	3,45	219	265	-	275	-	70,1	30,5
	2,2	2,55	304	366	180	150	70	72	31,2
K07-MS	3	3,45	304	366	250	220	70,3	72,3	32,5
	4	4,6	304	366	270	325	70,6	72,6	41
K08-MS	2,2	2,55	414	499	130	100	75,4	77,4	46,5
	3	3,45	414	499	200	175	75,7	77,7	47,5
	4	4,6	414	499	280	250	76	78	51
	5,5	6,3	414	499	325	375	76,3	78,3	61,5
K09-MS	3	3,45	536	647	125	100	76,5	78,5	49
	4	4,6	536	647	180	150	76,8	78,8	52,5
	5,5	6,3	536	647	275	250	77,1	79,1	63
	7,5	8,7	536	647	350	375	77,4	79,4	68
K10-MS	9,2	10,6	536	647	-	-	-	-	77,5
	4	4,6	663	800	130	85	77,1	79,1	62
	5,5	6,3	663	800	210	150	77,3	79,3	72,5
	7,5	8,7	663	800	290	250	77,6	79,6	77,5
	9,2	10,6	663	800	350	325	77,8	79,8	87
K11-MS	11	12,7	663	800	-	375	-	80,1	87,5
	5,5	6,3	782	944	160	115	77,4	79,4	75
	7,5	8,7	782	944	250	200	77,7	79,7	80
	9,2	10,6	782	944	300	270	78,2	80,2	89,5
	11	12,7	782	944	350	375	78,5	80,5	90
K12-MS	15	17,4	782	944	-	-	-	-	95
	7,5	8,7	915	1105	175	130	80	82	83,5
	9,2	10,6	915	1105	230	175	80,5	82,5	93
	11	12,7	915	1105	300	250	81	83	93,5
	15	17,4	915	1105	350	350	81,8	83,8	98,5
K75-MS	18,5	21,5	915	1105	-	-	-	-	128,5
	9,2	10,6	1022	1234	150	100	81	83	96,5
	11	12,7	1022	1234	200	150	81,5	83,5	97
	15	17,4	1022	1234	300	275	82,3	84,3	102
K75-MS	18,5	21,5	1022	1234	325	350	85,2	87,2	132
	4	4,6	477	576	150	100	76,4	78,4	51,5
	5,5	6,3	477	576	250	200	76,7	78,7	62
K75-MS	7,5	8,7	477	576	-	300	-	79	67

¹ Noise measured at 1 m distance with inlet and outlet ports piped, in accordance to ISO 3744.

² Value refers to the weight of the machine with 3 Phase motor if MOR range, without motor if GOR or GVR range.

N: Installed power

Q: Flow rate

P: Differential pressure

Leq: Noise

SERIES MS – RANGE MOR

VACUUM

2900 rpm (50 Hz)

3500 rpm (60 Hz)

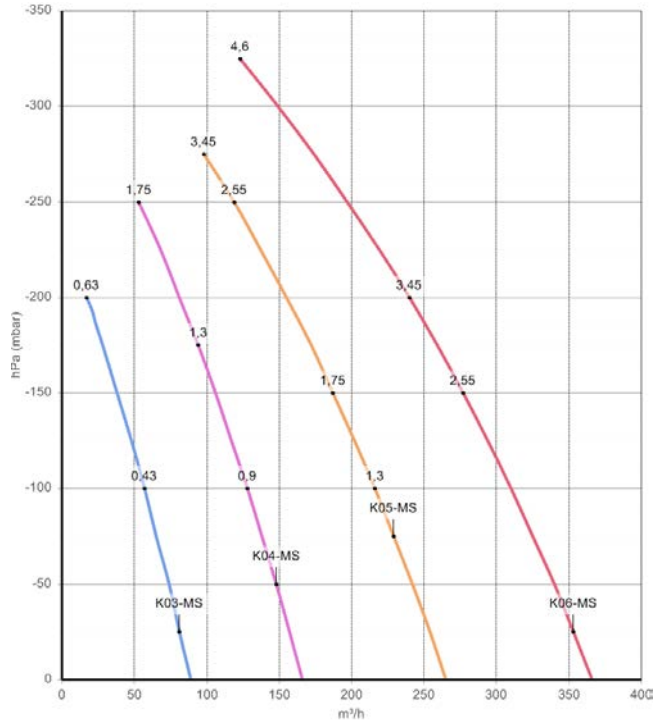
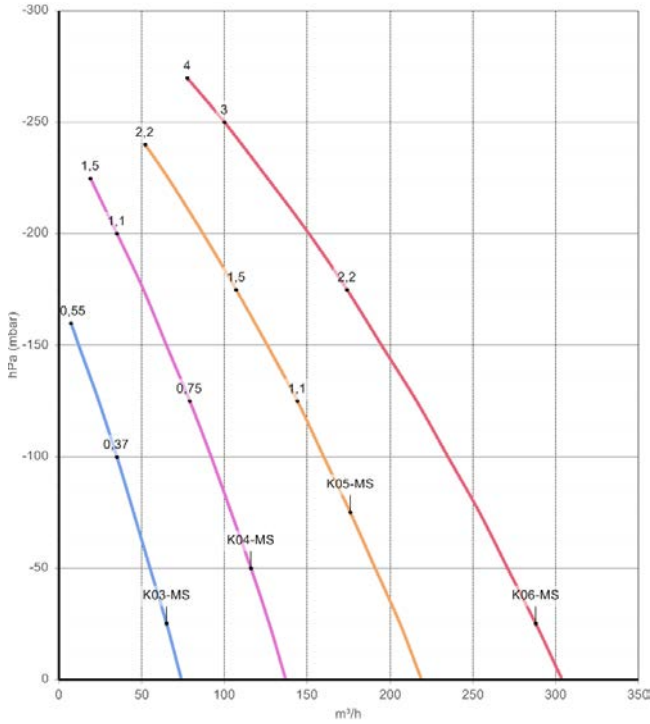

FLOW RATE

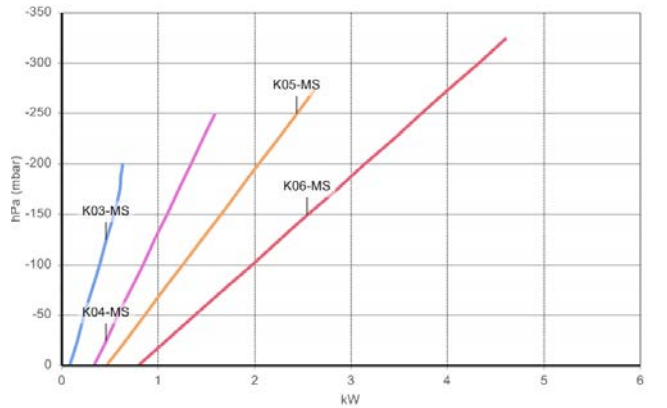
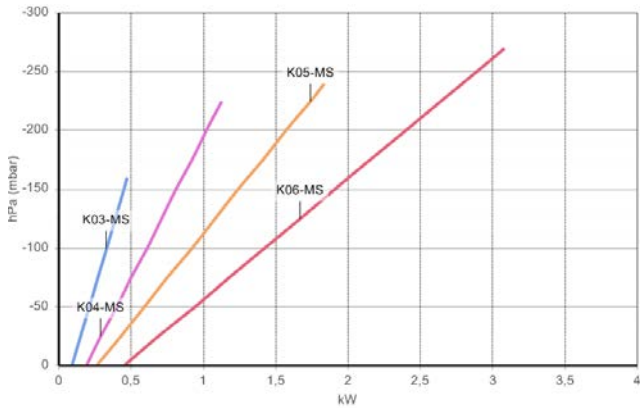

ABSORBED POWER

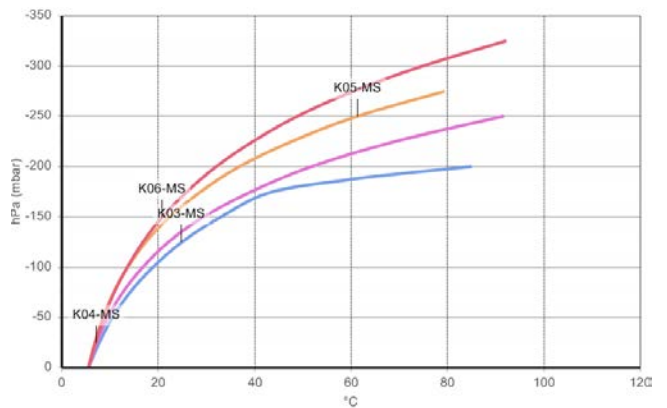
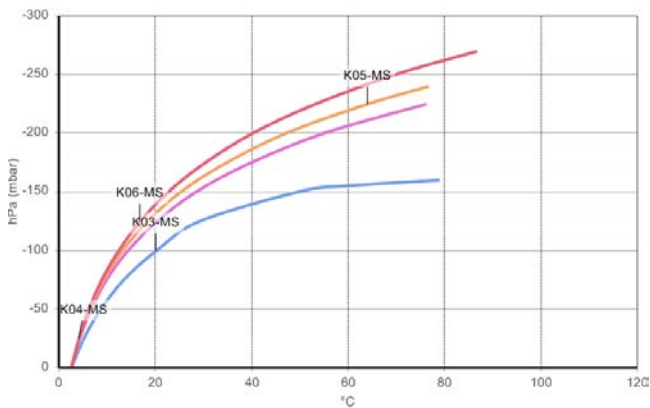

TEMPERATURE INCREASE

Curves refer to air at 20°C (68° F) temperature, measured at inlet port and 1013 mbar (29.92 In Hg) atmospheric backpressure (abs).
 Values for flow, power consumption and temperature rise: ± 10% tolerance
 Data can change without prior notice.

SERIES MS – RANGE MOR

DIMENSIONS (K03-MS/K04-MS/K05-MS/K06-MS)

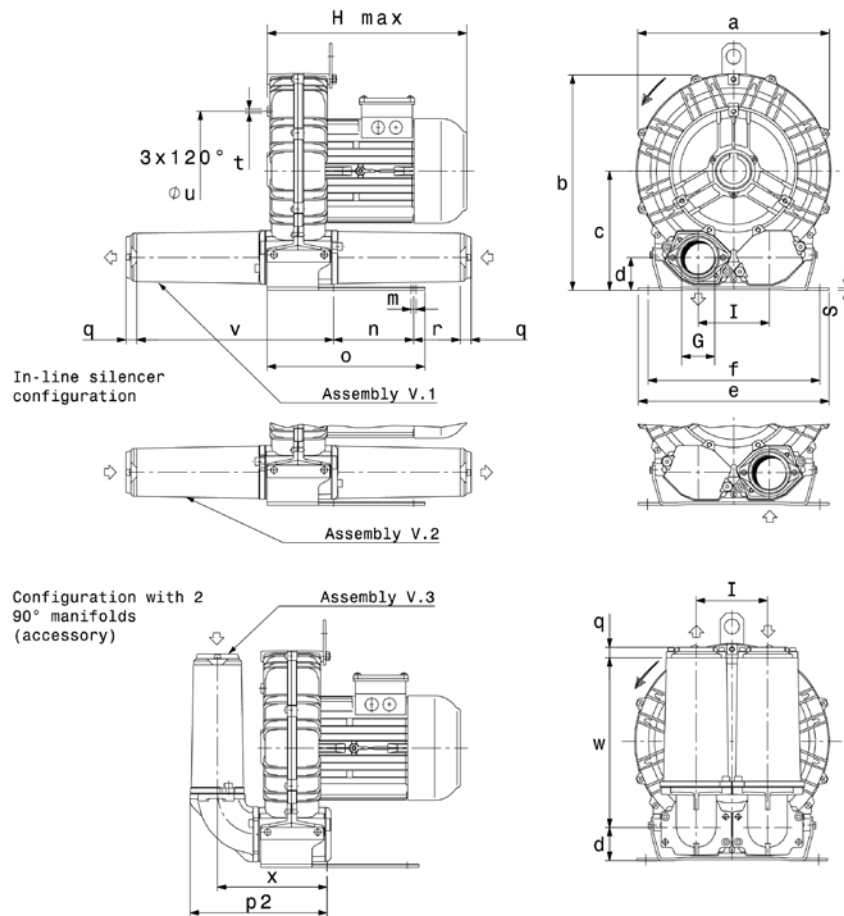

Dimensions in mm - FOR REFERENCE ONLY

Model	a	b	c	d	e	f	G	H
K03-MS	241	268	147	43	230	205	G 1" ¼	241
K04-MS	285	315	172	49	255	225	G 1" ½	310
K05-MS	327	365	200	54	320	260	G 2"	375
K06-MS	376	393	205	54	325	290	G 2"	400

Model	i	m	n	p1	p2	q	r	o
K03-MS	86	10	83	205	140	18	75	142
K04-MS	102	12	95	222	160	18	70	171
K05-MS	120	15	115	320	230	18	98	265
K06-MS	125	15	140	334	244	18	85	272

Model	s	t	u	v	w	x	z
K03-MS	4	M6	140	180	188	106	12
K04-MS	4	M6	175	195	188	120	18
K05-MS	4	M8	200	330	285	184	19
K06-MS	4	M8	240	332	285	198	19

SERIES MS – RANGE MOR

DIMENSIONS (K07-MS/K08-MS/K09-MS/K10-MS/K11-MS/K12-MS/K75-MS)

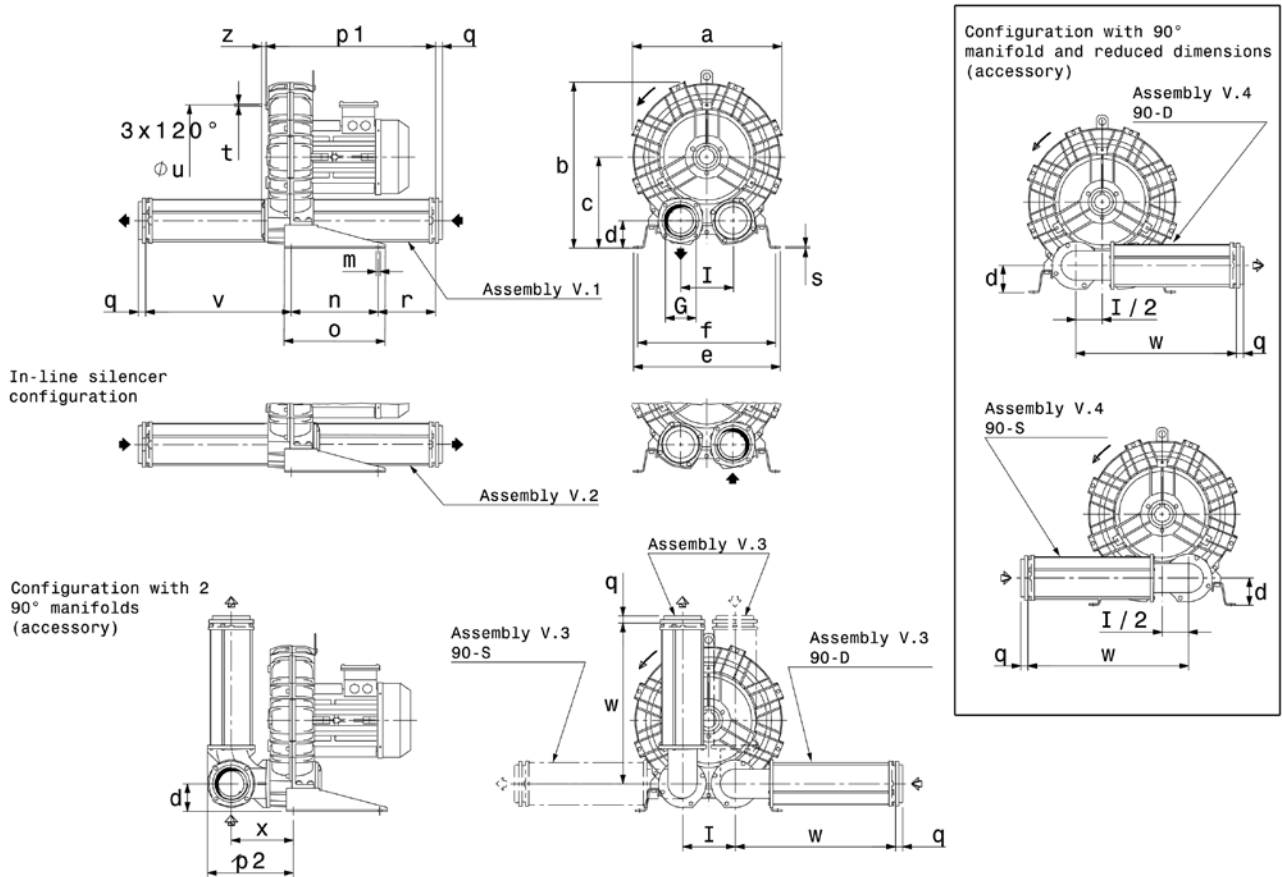

Dimensions in mm - FOR REFERENCE ONLY

Model	a	b	c	d	e	f	G	H
K07-MS	424	481	269	82	468	438	G 3"	445
K08-MS	457	498	269	82	478	448	G 3"	480
K09-MS	492	561	315	96	508	478	G 4"	490
K10-MS	516	573	315	96	508	478	G 4"	490
K11-MS	542	603	332	91	540	508	G 4"	590
K12-MS	548	605	332	91	540	508	G 4"	593
K75-MS	424	481	269	82	468	438	G 3"	445

Model	i	m	n	p1	p2	q	r	o
K07-MS	155	13	300	512	255	25	137	350
K08-MS	155	13	300	512	255	25	137	350
K09-MS	182	13	300	586	300	25	199	350
K10-MS	182	13	300	586	300	25	199	350
K11-MS	200	13	300	596	305	25	204	350
K12-MS	200	13	300	599	305	25	204	350
K75-MS	155	13	300	512	255	25	137	350

Model	s	t	u	v	w	x	z
K07-MS	5	M8	295	443	481	183	16
K08-MS	5	M8	310	443	481	183	16
K09-MS	5	M8	360	505	556	215	16
K10-MS	5	M8	360	505	556	215	16
K11-MS	5	M8	390	510	556	220	16
K12-MS	5	M8	390	510	556	220	13
K75-MS	5	M8	295	443	481	183	16