

SERIES K-MD MOR

TECHNICAL CHARACTERISTICS

- Aluminium alloy construction
- High efficiency impeller

OPTIONS

- Special Voltages (IEC 60038)
- Surface treatments
- Increased seal version



PRESSURE

Model	N 2900 rpm [kW]	N 3500 rpm [kW]	Q max 2900 rpm [m ³ /h]	Q max 3500 rpm [m ³ /h]	ΔP max 2900 rpm [hPa] (mbar)	ΔP max 3500 rpm [hPa] (mbar)	Leq ¹ 2900 rpm (Lp) [dB(A)]	Leq ¹ 3500 rpm (Lp) [dB(A)]	Weight ² max [kg]
K07R-MD	2,2	2,55	181	218	275	215	71,5	73,5	46
	3	3,45	181	218	400	335	72	74	47
	4	4,6	181	218	575	500	72,5	74,5	50,5
	5,5	6,3	181	218	650	650	73	75	61
K08R-MD	3	3,45	236	285	250	180	73,9	75,9	49,5
	4	4,6	236	285	375	300	74,2	76,2	53
	5,5	6,3	236	285	550	475	74,6	76,6	63,5
	7,5	8,7	236	285	650	650	75	77	68,5
K09-MD	4	4,6	310	374	285	200	74,9	76,9	65,5
	5,5	6,3	310	374	425	350	76	78	76
	7,5	8,7	310	374	650	560	77,5	79,5	81
	9,2	10,6	310	374	725	725	78,5	80,5	90,5
K10-MD	5,5	6,3	386	466	340	260	77,9	79,9	77,5
	7,5	8,7	386	466	515	425	78,3	78,7	82,5
	9,2	10,6	386	466	660	560	78,7	80,7	92
	11	12,7	386	466	750	700	79,4	81,4	92,5
K11-MD	5,5	6,3	430	519	250	175	78,8	80,8	91
	7,5	8,7	430	519	400	320	79,1	81,1	96
	9,2	10,6	430	519	525	425	79,4	81,4	105,5
	11	12,7	430	519	650	550	79,7	81,7	106
	15	17,4	430	519	750	750	80	82	108
K12-MD	7,5	8,7	472	570	225	-	80	82	99,5
	9,2	10,6	472	570	350	200	80,3	-	109
	11	12,7	472	570	450	300	80,6	82,6	109,5
	15	17,4	472	570	650	550	80,9	82,9	111,5

INSTALLATION

- For proper use, the blower should be equipped with INLET FILTER and SAFETY VALVE; other accessories available on request
- Ambient temperature from -15° to +40°C (+5° to +104° F)
- Specifications subject to change without notice
- Before installation read carefully all instructions

¹ Noise measured at 1 m distance with inlet and outlet ports piped, in accordance to ISO 3744.

² Value refers to the weight of the machine with 3 Phase motor if MOR range, without motor if GOR or GVR range.

N: Installed motor power

Q: Flow rate

ΔP: Differential pressure

Leq: Noise level

PRESSURE

2900 rpm (50 Hz)

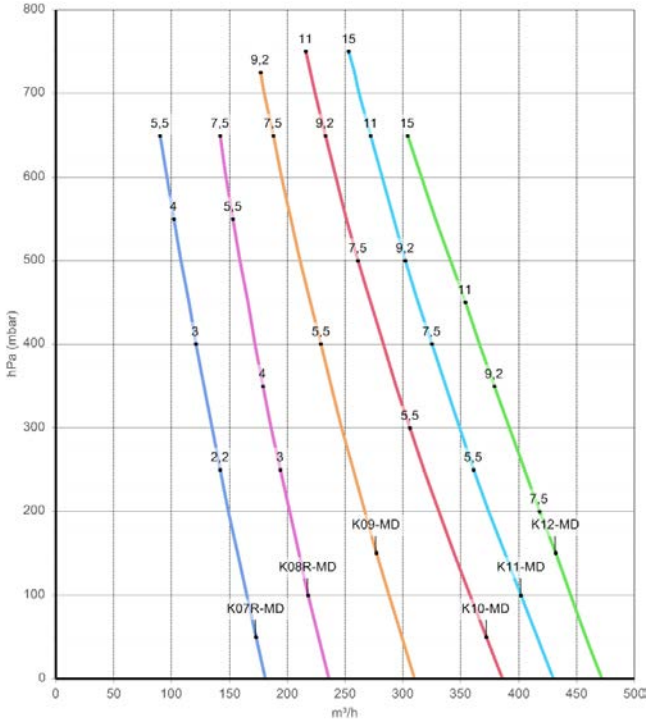

3500 rpm (60 Hz)

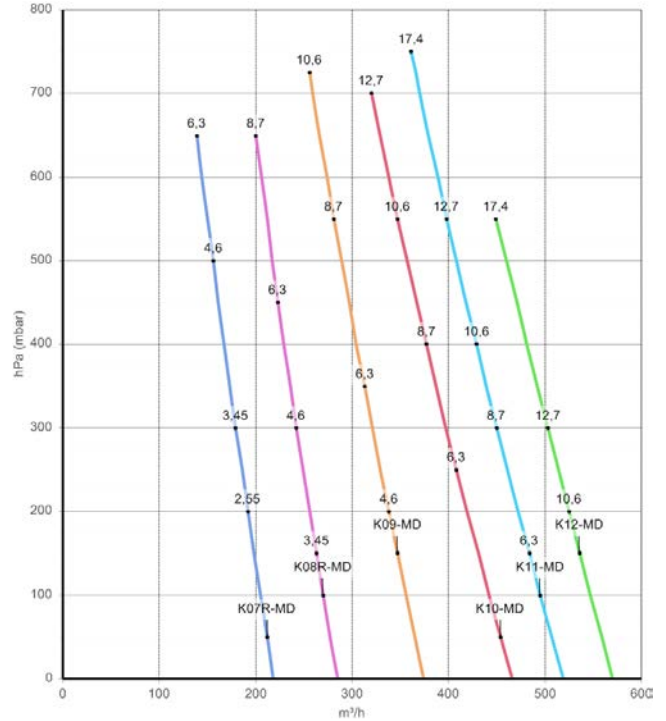

FLOW RATE

ABSORBED POWER

TEMPERATURE INCREASE

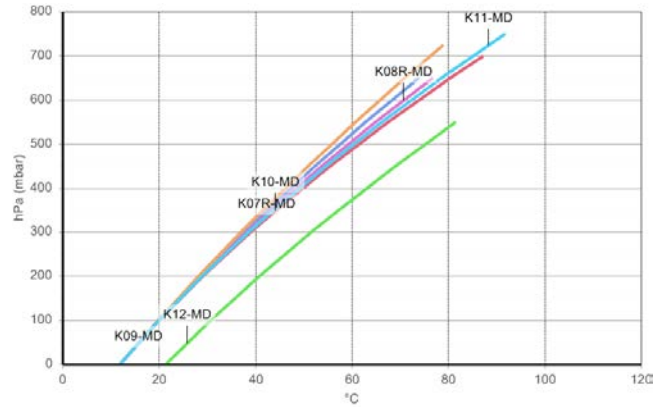
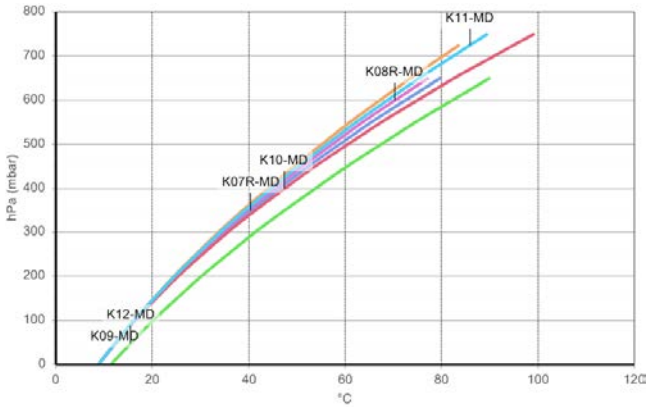
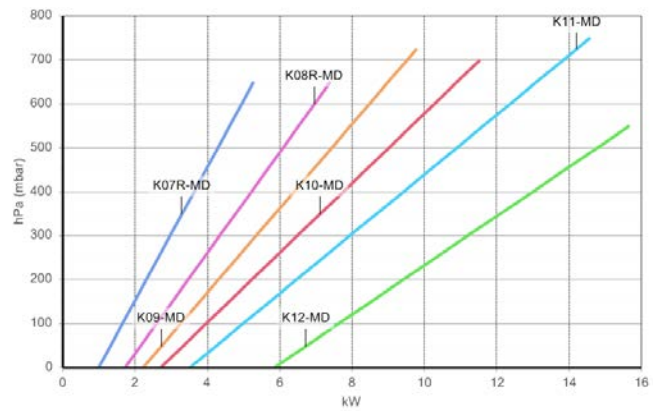
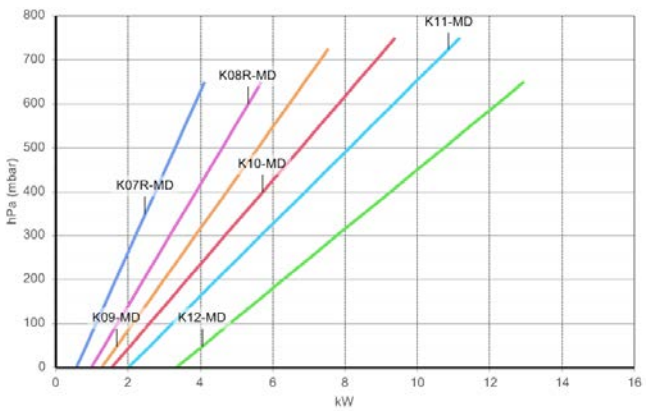

Curves refer to air at 20°C (68° F) temperature and 1013 mbar (29.92 In Hg) atmospheric pressure (abs) measured at inlet port.
 Values for flow, power consumption and temperature rise: ±10% tolerance.
 Data can change without prior notice.

VACUUM

Model	N 2900 rpm [kW]	N 3500 rpm [kW]	Q max 2900 rpm [m³/h]	Q max 3500 rpm [m³/h]	ΔP max 2900 rpm [hPa] (mbar)	ΔP max 3500 rpm [hPa] (mbar)	Leq ¹ 2900 rpm (Lp) [dB(A)]	Leq ¹ 3500 rpm (Lp) [dB(A)]	Weight ² max [kg]
K07R-MD	2,2	2,55	181	218	275	215	70,5	72,5	46
	3	3,45	181	218	400	335	71	73	47
	4	4,6	181	218	450	450	71,5	73,5	50,5
	5,5	6,3	181	218	-	-	-	-	61
K08R-MD	3	3,45	236	285	250	180	73,4	75,4	49,5
	4	4,6	236	285	375	300	73,7	75,7	53
	5,5	6,3	236	285	450	450	74,1	75,5	63,5
	7,5	8,7	236	285	-	-	-	-	68,5
K09-MD	4	4,6	310	374	285	200	74,4	76,4	65,5
	5,5	6,3	310	374	425	350	75,5	77,5	76
	7,5	8,7	310	374	475	475	77	79	81
	9,2	10,6	310	374	-	-	-	-	90,5
K10-MD	5,5	6,3	386	466	340	260	78,4	80,4	77,5
	7,5	8,7	386	466	500	425	78,7	80,7	82,5
	9,2	10,6	386	466	-	500	-	81	92
	11	12,7	386	466	-	-	-	-	92,5
K11-MD	5,5	6,3	430	519	250	175	78,4	80,4	91
	7,5	8,7	430	519	400	320	78,7	80,7	96
	9,2	10,6	430	519	500	425	79	81	105,5
	11	12,7	430	519	-	500	-	81,3	106
	15	17,4	430	519	-	-	-	-	108
K12-MD	7,5	8,7	472	570	225	-	79,6	-	99,5
	9,2	10,6	472	570	350	200	79,9	81,9	109
	11	12,7	472	570	450	300	80,2	82,2	109,5
	15	17,4	472	570	-	450	-	82,5	111,5

¹ Noise measured at 1 m distance with inlet and outlet ports piped, in accordance to ISO 3744.

² Value refers to the weight of the machine with 3 Phase motor if MOR range, without motor if GOR or GVR range.

N: Installed power

Q: Flow rate

ΔP: Differential pressure

Leq: Noise Level

DIMENSIONS (K07R-MD/K08R-MD/K09-MD/K10-MD/K11-MD/K12-MD)

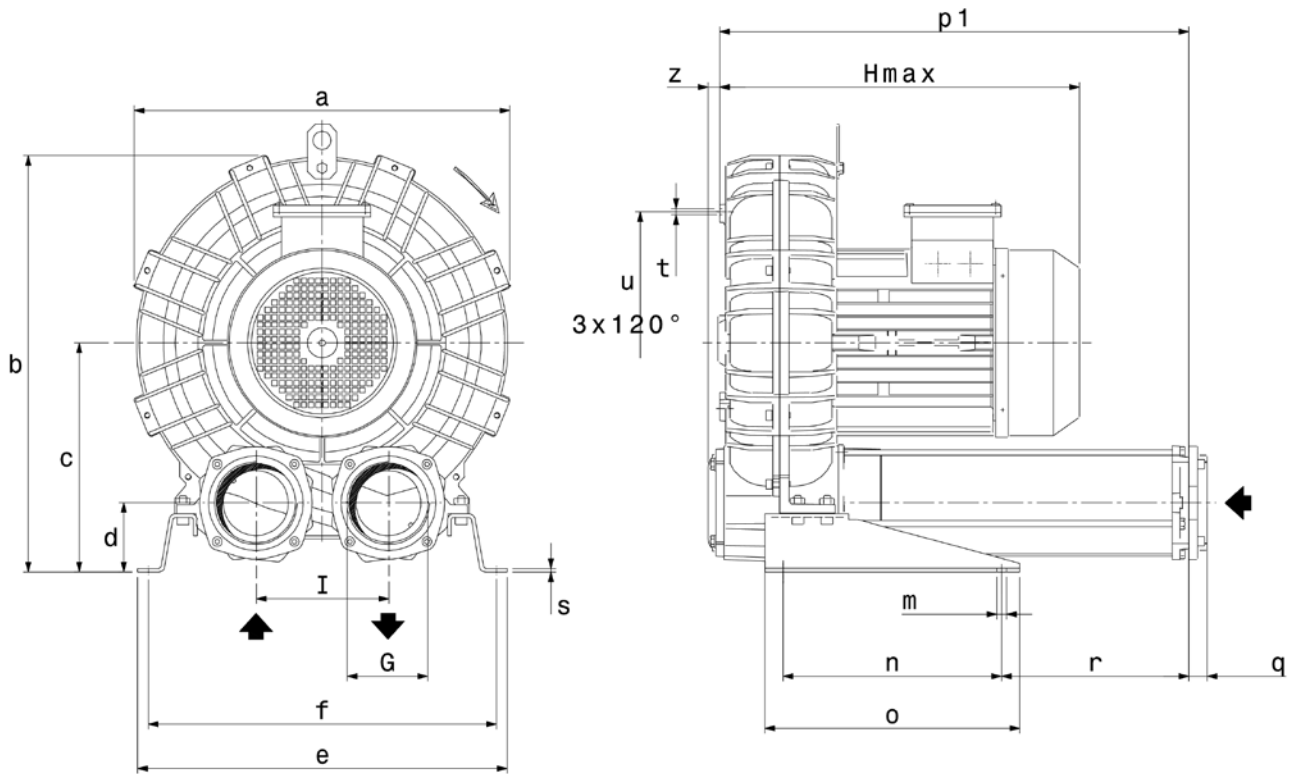

Dimensions in mm - FOR REFERENCE ONLY

Model	a	b	c	d	e	f
K07R-MD	424	481	269	82	468	438
K08R-MD	457	498	269	82	478	448
K09-MD	492	561	315	96	508	478
K10-MD	516	573	315	96	508	478
K11-MD	542	603	332	91	538	508
K12-MD	548	606	332	91	538	508

Model	G	H	i	m	n	o
K07R-MD	G 2"	445	155	13	300	350
K08R-MD	G 2"	445	155	13	300	350
K09-MD	G 4"	490	182	13	300	350
K10-MD	G 4"	490	182	13	300	350
K11-MD	G 4"	495	200	13	300	350
K12-MD	G 4"	498	200	13	300	350

Model	p1	q	r	s	t	u	z
K07R-MD	418	18	43	5	M8	295	16
K08R-MD	418	18	43	5	M8	310	16
K09-MD	644	25	257	5	M8	360	16
K10-MD	644	25	257	5	M8	360	16
K11-MD	654	25	262	5	M8	390	16
K12-MD	657	25	262	5	M8	390	13